



# SICKLE BAR ASSEMBLIES

Current as of 12/12/2011

---



## PARTS LISTING WITH MOUNTING AND OPERATING INSTRUCTIONS

---

**Tiger Corporation**  
3301 N. Louise Ave.  
Sioux Falls, SD 57107  
1-800-843-6849  
1-605-336-7900  
[www.tiger-mowers.com](http://www.tiger-mowers.com)

06090005

# TO THE OWNER / OPERATOR / DEALER

All implements with moving parts are potentially hazardous. There is no substitute for a cautious, safe-minded operator who recognizes the potential hazards and follows reasonable safety practices. The manufacturer has designed this implement to be used with all its safety equipment properly attached to minimize the chance of accidents.

**BEFORE YOU START!!** Read the safety messages on the implement and shown in this manual. Observe the rules of safety and use common sense!

**READ AND UNDERSTAND THIS MANUAL! Non-English speaking operators will need to GET THE MANUAL TRANSLATED as needed!**



# DANGER

**FAILING TO FOLLOW SAFETY MESSAGES AND OPERATING INSTRUCTIONS CAN CAUSE SERIOUS BODILY INJURY OR EVEN DEATH TO OPERATOR AND OTHERS IN THE AREA.**



1. Study and understand Operator's Manuals, Safety Decals, and Instructional Decals for tractor and implement to prevent misuse, abuse, and accidents. Practice before operating in a confined area or near passersby.

● Learn how to stop engine suddenly in an emergency. Be alert for passersby and especially children

2. Allow no children on or near folding mower or tractor. Allow no riders on tractor or implement. Falling off may cause serious injury or death from being run over by tractor or mower or contact with rotating blades.

3. Operate only with tractor having Roll-Over Protective Structure (ROPS) and with seat belt securely fastened to prevent injury and possible death from falling off or tractor overturn.

● Personal Protective Equipment such as Hard Hat, Safety Glasses, Safety Shoes, & Ear Plugs are recommended.

4. Block up or support raised machine and all lifted components securely before putting hands or feet under or working underneath any lifted component to prevent crushing injury or death from sudden dropping or inadvertent operation of controls. Make certain area is clear before lowering or folding

5. Before transporting, put Lift Lever in detent or full-lift position. Install Transport Safety Devices securely on folding mowers. Put Booms securely in Transport Rest.

● Folding and Boom Mowers have raised center of gravity. Slow down when turning and on hillsides.

6. Make certain that SMV sign, warning lights, and reflectors are clearly visible. Follow local traffic codes.

7. Never operate with Cutting Head or Folding Section raised if passersby, bystanders, or traffic are in the area to reduce possibility of injury or death from objects thrown by Blades under Guards or mower structure.

8. Before dismounting, secure implement in transport position or lower to ground.

● Put tractor in park or set brake, disengage PTO, stop engine, remove key, and wait until noise of rotation has ceased to prevent crushing by entanglement in rotating parts which could cause injury or death.

● Never mount or dismount a moving vehicle. Crushing from rollover may cause serious injury or death.



02967827

Warranty Information: Read and understand the complete Warranty Statement found in this manual. Fill out the Warranty Registration form in full and return it within 90 days. Make certain the Serial Number of the machine is recorded on the Warranty Card, and form that you retain.

# FORWARD

This manual contains information about many features of the Tiger mowing and roadside maintenance equipment. Some of these include: Safety precautions, Assembly instructions, Operations, Maintenance and Parts. This manual will also assist you in the proper break-in, daily care, and troubleshooting of your new mower.

We recommend that you read carefully the entire manual before operating the unit. Also, time spent in becoming fully acquainted with its performance features, adjustments, and maintenance schedules will be repaid in a long and satisfactory life of the equipment.

## **Troubleshooting - Please, before you call, help us to help you!**

Please look at the equipment to observe what is happening, then:

- Classify the problem
  - Hydraulic, electrical or mechanical - Read the trouble shooting section
  - Tractor or Truck chassis - Contact vehicle dealer
  
- If unable to correct the problem yourself, contact your local Tiger Dealer after gathering:
  - Machine model \_\_\_\_\_
  - Serial number \_\_\_\_\_
  - Dealer name \_\_\_\_\_
  - Detailed information about the problem including results of troubleshooting

**Attention Owner / Operator / Dealer:** It is your obligation to read, and understand, the warranty information section located at the back of this manual denoting that the purchaser understands the safety issues relating to this machine and has received and will read a copy of this manual.

If at any time, you have a service problem with your Tiger mower, Contact your local dealer for service and parts needed.

MANUFACTURED BY:

**Tiger Corporation**

3301 N. Louise Ave.

Sioux Falls, SD 57107

1-800-843-6849

1-605-336-7900

www.tiger-mowers.com

DISTRIBUTED BY:

\_\_\_\_\_

1- \_\_\_\_\_ - \_\_\_\_\_ - \_\_\_\_\_

1- \_\_\_\_\_ - \_\_\_\_\_ - \_\_\_\_\_



# TABLE OF CONTENTS

<b>SAFETY</b> _____	1-1
Safety Information_____	1-2
<b>ASSEMBLY / MOUNTING SECTION</b> _____	2-1
<b>OPERATION SECTION</b> _____	3-1
<b>MAINTENANCE SECTION</b> _____	4-1
<b>PARTS SECTION</b> _____	5-1
Parts Ordering Guide_____	5-2
Parts Table of Contents_____	5-3
<b>Common Parts Section</b> _____	6-1
<b>WARRANTY INFORMATION</b> _____	7-1



1012

**This symbol means:**

## **CAUTION – YOUR SAFETY IS AT RISK!**

When you see this symbol, read and follow the associated instructions carefully or personal injury or damage may result.

Tiger is a registered trademark.





# **ASSEMBLY SECTION**

# ASSEMBLY

**Before attempting to mount or service your Tiger mower, it is important to read and understand all of the information in the Safety section of this manual.**

Check complete shipment list against the packing list to make sure there are no shortages. Make certain the tractor model is the appropriate one for the mower received!

**WARNING!**



Always use a floor jack, hoist or fork lift to lift and raise heavy parts.

Read and understand the entire assembly section instructions before attempting to mount your Tiger mower. Refer to the parts section of this manual for detailed illustrations to locate all parts.



# ASSEMBLY

## MAIN FRAME INSTALLATION

With an overhead hoist, raise the frame up to the correctly matching mounting holes. Install pins and all other hardware as shown in main frame parts section to secure the main frame to the boat.

## HYDRAULIC TANK & MOTOR INSTALLATION

Install all fittings and hoses onto the tank as shown in the parts section.

The tank is part of a contained package with the motor and pump which should be bolted to the Aluminum Main Frame with the hardware shown in the parts section.

## FILLING HYDRAULIC RESERVOIR

Refer to the maintenance section for filling specifications and hydraulic oil requirements.

**NOTE: Starting or running your Tiger mower before filling reservoir will cause serious damage to hydraulic pump.**

# ASSEMBLY

## CABLE VALVE MOUNT

Align the cable valve mount to the holes at the desired height. Secure the bracket to the base of the boom with the supplied hardware as shown in the parts section. Then place and secure the lift valve on top of the mounting plate. Route the hydraulic lines from the lift valve to the hydraulic cylinders as noted on the lift valve page of the parts section.

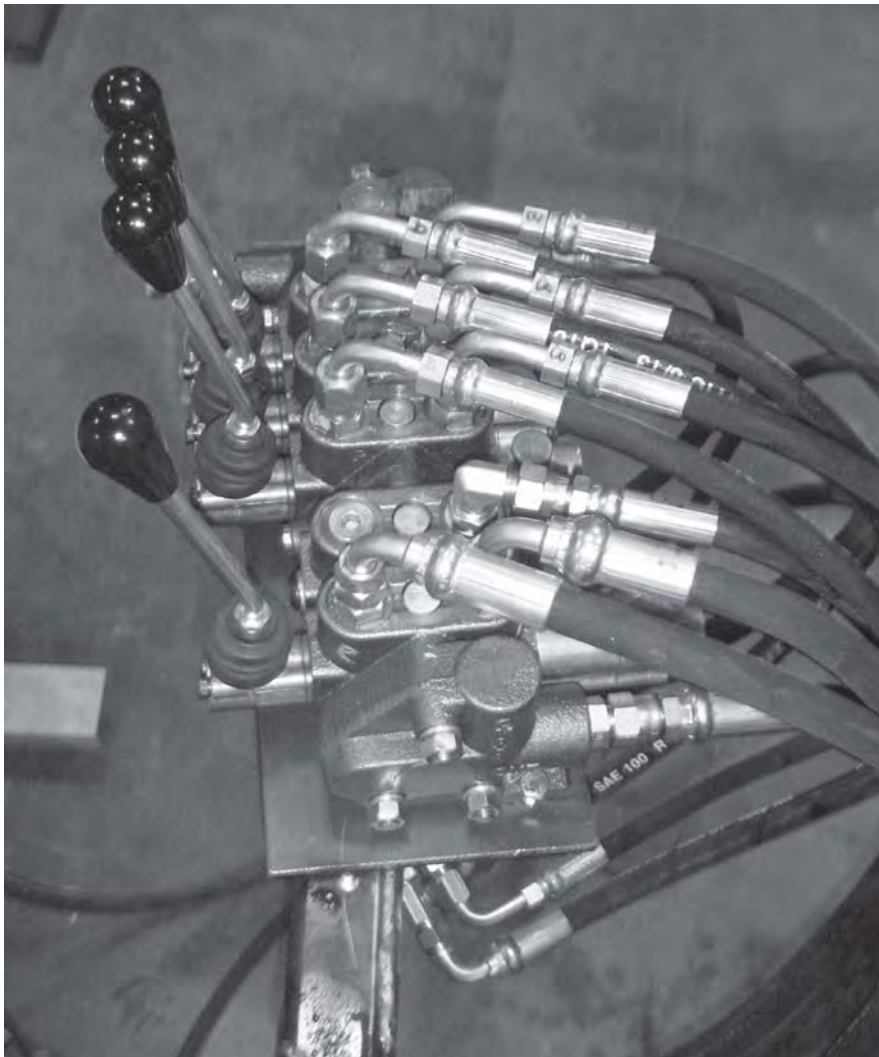

# ASSEMBLY

## MAIN BOOM INSTALLATION

Install the Boom Mount onto the main frame as shown in the parts section using a hoist. Secondly, attach the Main Boom section into the Boom Mount. Attach the Main Boom Cylinder. Next, attach the Secondary Boom section to the Main Boom. Attach the Secondary Boom Cylinder. Once the Secondary Boom is attached, install the Linkages and Linkage Cylinder. Lastly, bolt the mower (with attached motor) to the Secondary Boom.

**GREASE HINGE PIN ZERKS ON BOOM AFTER ASSEMBLY, ONCE UNDER LOAD WITH BOOM ELEVATED AND AGAIN AT REST WITH BOOM SUPPORTED**

## INSTALLING O-RING FITTINGS

Installing straight, 45° and 90° O-rings requires that the O-ring and washer be up against the swivel body. Insert the swivel and turn in until the swivel is pointed in the desired direction and O-ring contact is made. Hold swivel in set direction with a wrench and turn the O-ring nut away from the swivel body and carefully tighten.

# ASSEMBLY

## BOOM HYDRAULIC DIAGRAM

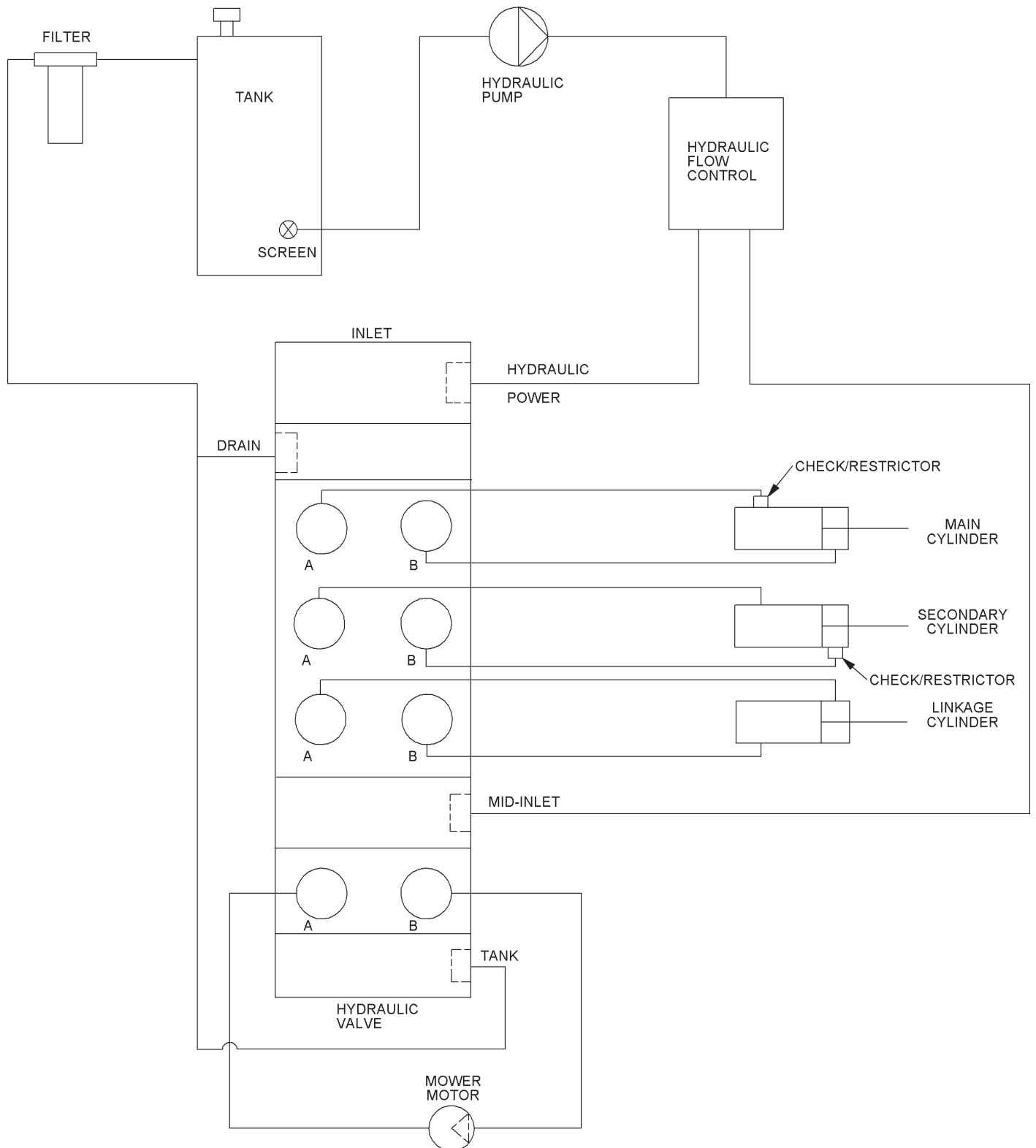



# ASSEMBLY

## FINAL PREPARATION FOR OPERATION

Place operators safety and operation decals on the valve mount and hydraulic tank where they are clearly visible to the operator. These decals should be understood by each operator of the machine in conjunction with the safety and operation section of this book. The decals are to be maintained in good condition as a reminder to the operator, and should be replaced if damaged.

Finally, all bosses, pins and pivot points will need to be greased as instructed in the maintenance section of this manual. The hydraulic reservoir can also be filled with the recommended fluid (see maintenance section) and the filter installed in the the tank. Double check all fittings and fasteners BEFORE starting tractor. Also secure any loose hoses together with zip ties and wrap with split hoses where friction may occur on the hoses.

### WARNING!



BEFORE starting or operating the tractor you must read and understand the safety and operation sections of this manual completely.

**BE SURE THE BALL VALVES ARE OPEN!** Start tractor and allow instruments to stabilize. Using a piece of paper or cardboard as noted in the safety and maintenance sections, check all fittings and connections for hydraulic leaks.

If a leak is found, you must shut down the tractor, set the cutter on the ground. Before attempting to fix the leak, you must actuate the lift valve handles several times to relieve any pressure in the lines.

**Before operating the mower**, the cutter head and boom should be slowly moved throughout the full range of motion. Watch for any condition that would cause pinching or excess stress on the hoses.

## MOWER TESTING

Take the boat to a place free of loose objects in the water. Operate the cylinders through their full range of motion again, to clear the lines of air. Follow the instructions in the operation section to operate the mower. Vibration of the mower should be minimal at all times.

**If any parts of this assembly section, or any other section of this manual are not clearly understood you must contact your dealer or the address on the front of this manual for assistance!**

# **OPERATION SECTION**

# OPERATION

**Safety** is of primary importance to the owner / operator and to the manufacturer. The first section of this manual includes a list of Safety Messages, that, if followed, will help protect the operator and bystanders from injury or death. Many of the messages will be repeated throughout the manual. The owner / operator / dealer should know these Safety Messages before assembly and be aware of the hazards of operating this mower during assembly, use, and maintenance.

The **Safety Alert Symbol** combined with a signal word, as seen below, is intended to warn the owner / operator of impending hazards and the degree of injury possible during operation.

DANGER!



Indicates an imminently hazardous situation that, if not avoided, **WILL** result in **DEATH OR VERY SERIOUS INJURY**.

WARNING!



Indicates an imminently hazardous situation that, if not avoided, **COULD** result in **DEATH OR SERIOUS INJURY**.

CAUTION!



Indicates an imminently hazardous situation that, if not avoided, **MAY** result in **MINOR INJURY**.

**IMPORTANT!**

Identifies special instructions or procedures that, if not strictly observed, could result in damage to, or destruction of the machine, attachments or the environment.

**NOTE:** *Identifies points of particular interest for more efficient or convenient operation or repair.* (SG-1)

WARNING!



Many varied objects, such as wire, cable, rope, or chains, can become entangled in the operating parts of the mower head. Such a situation is extremely hazardous and could result in serious injury or even death. Inspect the cutting area for such objects before mowing. Remove any like object from the site. Never allow the cutting blades to contact such items.

(SGM-6)



# OPERATION

## CAUTION!



**Before any operation of boat and mower**, the user should read and understand the safety and operating instructions for both the boat and the mower. The user should also be familiar with the location and functions of the units instruments and controls. Being familiar with the machine and it's controls will increase efficiency and reduce possibility of serious injury or damage to the unit. The operator should work slowly and carefully until he feels comfortable with the machine. Speed and skill will be attained much easier if the necessary time is spent to familiarize yourself with the machine and its operations.

## WARNING!



Extreme care should be taken when operating near loose objects such as gravel, rocks, wire, and other debris. Inspect the area before mowing. Foreign objects should be removed from the site to prevent machine damage and/or bodily injury or even death. Any objects that cannot be removed must be clearly marked and carefully avoided by the operator. Stop mowing immediately if blades strike a foreign object. Repair all damage before resuming mowing. (SGM-5)



## STARTING BOAT AND MOWER

Check the operators manual received from the boat manufacturer, for their recommendation and procedures pertaining to your particular make and model.

## WARNING!



When mower parts are in motion, serious injury may occur if caution is not used or danger is not recognized. Never allow bystanders within **60 feet** of the machine when mower is in operation.



Be sure the ball valves on the mower hydraulic tank are **OPEN** before starting the tractor. Serious damage to the hydraulic system can occur if the valves are not open.

## WARNING!



Check to make sure mower switch is in the "**OFF**" position. The unit is designed not to start if the switch is in the "on" position. If tractor starts with switch on, turn off tractor and contact your local Tiger dealership for assistance.

# OPERATION

## LEARNING BOOM AND MOWER OPERATION

Start the motor and allow the engine to stabilize. Without starting the mower, practice positioning the boom and mower. Remember, speed and skill will be attained easier if the necessary time is spent familiarizing yourself with the machine and its operations. When you feel comfortable at controlling the position of the mower, return the mower to the travel position, and transport the mower to the desired mowing location.

If mowing for the first time, we recommend choosing a shore area relatively flat with a minimum of sign posts, guard rails, etc. As always, you should inspect the area for other objects that can cause potential hazards and removing them before mowing.

# OPERATION

## VALVE CONTROLS

A control lever decal similar to the one shown below should be near the control valve to remind the operator of the lever functions.

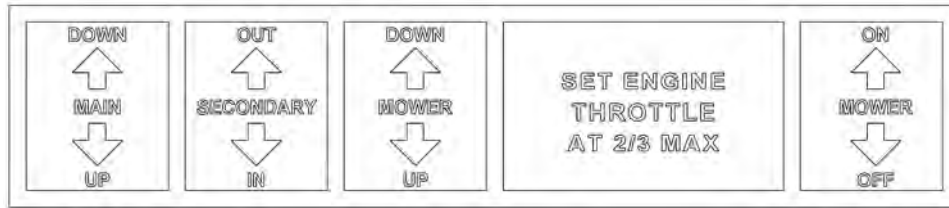

The main control valve on the Tiger Boom Mower has four sections with tapered spools, located near the drivers seat. The malfunction of a section of the valve does not necessitate the replacement of the entire “bank”, only the faulty section. Each section of the valve controls a certain position of the boom or mower. Seated in the operators seat, the controls from left to right are #1 - primary(main) boom, #2 – secondary boom, #3 – mower tilt, #4 – motor on-off.

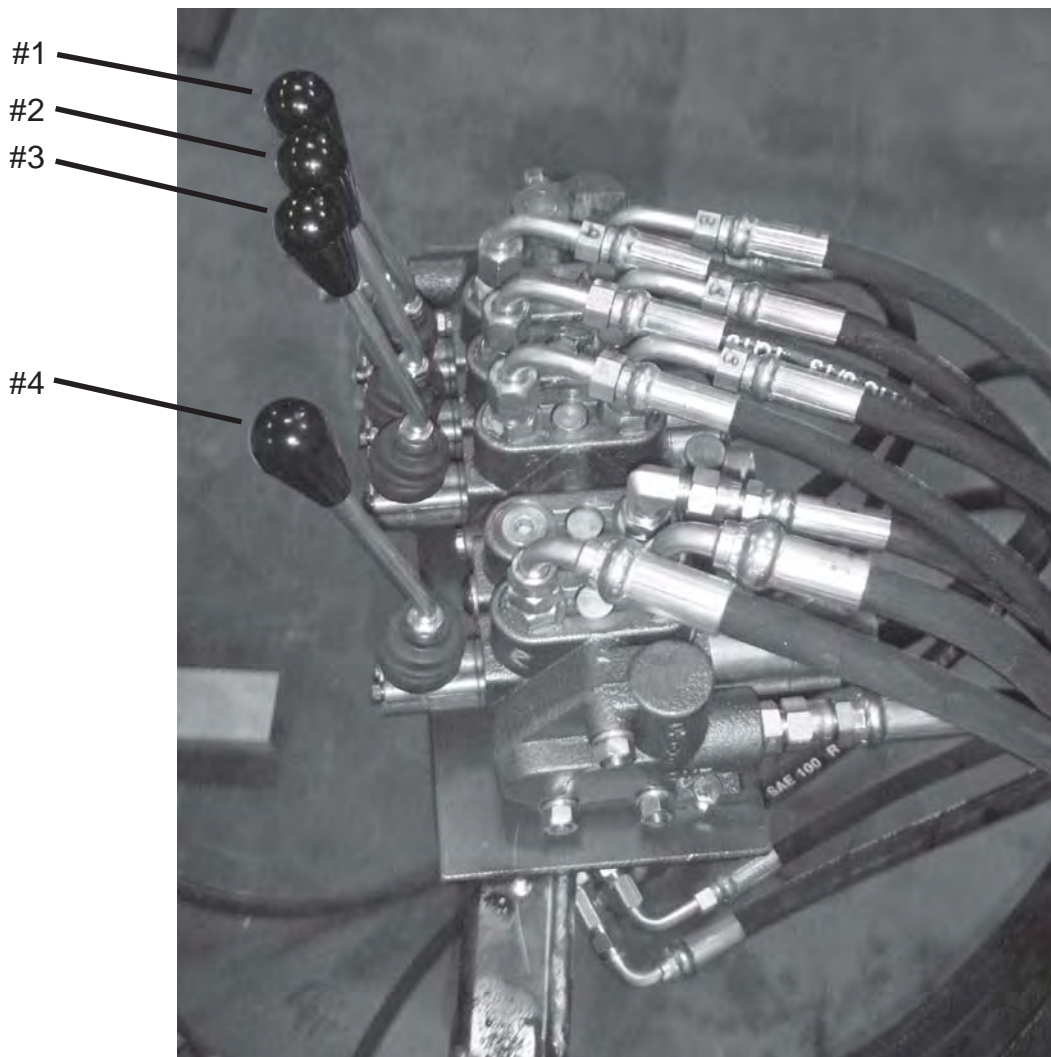

# OPERATION

**LEVER #1  
MAIN BOOM**

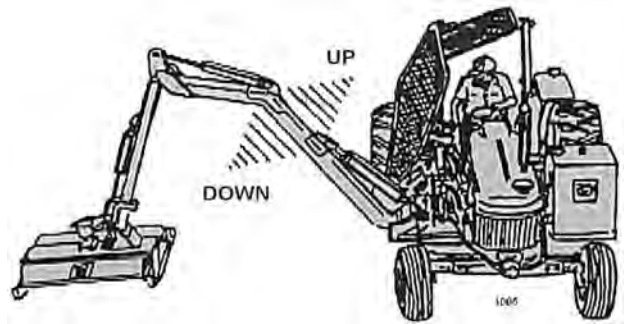

**LEVER #2  
SECONDARY BOOM**

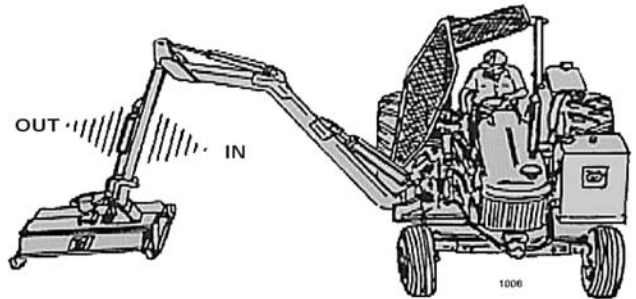

**LEVER #3  
MOWER TILT**

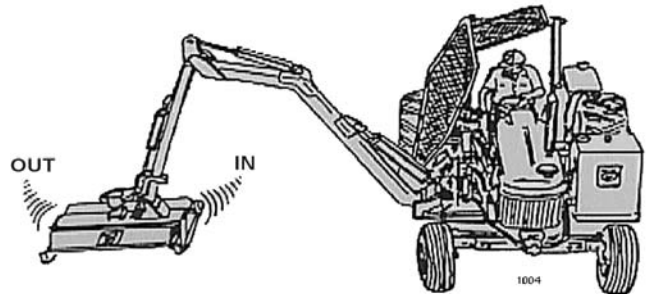

# OPERATION

## MOWER OPERATION

**WARNING!**



When parts are in motion, serious injury may occur if caution is not used or danger is not recognized. Never allow bystanders within **60 feet** of the machine when in operation. Extreme care should be taken when operating near loose objects – such as gravel, rocks and debris. These conditions should be avoided.

The parts in this machine have been designed and tested for rugged use. However, they could fail upon impact with heavy solid objects – such as steel guard rails, concrete abutments, etc., causing them to be thrown at a very high velocity. Never allow cutter head to contact such objects. Inspecting the cutting area for such objects and removing them prior to mowing can help eliminate these potential hazards.

Once on location, lower the mower in front of the material to be cut, so the mower does not have to start under a load. With the boat at an idle, engage mower. Bring mower up to two-third of maximum R.P.M. and **slowly** move boat forward into the material.

A sickle bar mower should be carried so that the mower weight is carried by the boom when mowing. When the sickle bar mower is carried this way, the ground will not: cause damage to the knives, cause damage to the boom, and possibly move the boat in an unexpected manner.

## SICKLE BAR BOOM MOWER

The sickle bar boom mower was designed for cutting brush and foliage up to 2 inches in diameter or multiple branches that have a total cross section area equivalent to one 2 inch branch.

During mower operation, the throttle must be used to set engine speed at two-thirds of maximum R.P.M. This reduces the possibility of cutter assembly damage.

The horizontal positioning action of the boom is designed to position the cutting head and provide a limited pressure relief when excessive pressure is applied to the boom. Do not force the cutting head into heavy branches or stumps. Damage to the unit may result.

**CAUTION!**



When using the mower for trimming small branches or thick grass, let the mower saw into them. Do not lower the mower head down directly onto a bush. The mower blades are designed to cut with the front, and misuse cause damage to the mower and a hazardous situation for the operator.

# OPERATION

## CAUTION!



Powering the boom down, forcing mower onto the ground may damage mower and it's attachment to the boom, creating a potentially hazardous situation.

To ensure a clean cut, engine speed should be maintained at approximately two-thirds of the maximum R.P.M.

## CAUTION!



**DO NOT** use excessive force when positioning cutting head into heavy branches or stumps. Damage to the unit may result. It is best to let the cutter head "eat away" slowly at heavy cutting jobs.

The mower will operate more efficiently in tougher conditions and with less power if the knives are kept sharp. If the mower begins to vibrate, stop the boat, check for wire wrapped around the mower or damaged knives. When replacing knives, it is recommended that you replace all knives with new knives to ensure proper balance so the mower will not vibrate severely or bind. Severe vibration may result if knives with unequal wear are used.

## WARNING!



If bystanders approach within 60 feet while mower is in operation turn mower lever to "OFF" immediately! After shutdown, never leave the boat or allow bystanders to approach within **60 FEET** of the unit until all motion stops completely.

If cutter jams and stops, turn mower lever to "OFF", and move the boat "AFT". Normally this action will clear the cutter head. If not, tilt mower until adjacent to the secondary boom, then stow the boom in the boomrest. Shut off the boat and allow all motion to cease. At that point it is safe to leave the boat and clear the cutter head manually.

After the first day of operation, all bolts should be checked and tightened securely. This should be done periodically to ensure the bolts do not become loose and cause damage to the tractor or mower, or injury to the operator.

# OPERATION

## TRANSPORTING MOWER

### **Transporting under the units own power:**

When transporting between job sites or between cutting passes, the following procedure should be followed: Shut off the power to the cutting head and allow all motion to come to a complete stop. Raise the boom above ground material or foilage, being cautious of overhead obstructions such as highline wires. Tilt the deck completely towards the secondary boom. Stow the boom in the boomrest. Secure the sickle bar mower.

### **Transporting unit by trailer:**

Shut off the power to the cutting head and allow all motion to come to a complete stop. Raise the boom above ground material or foilage, being cautious of overhead obstructions such as highline wires. Tilt the deck completely towards the secondary boom. Stow the boom in the boomrest. Secure the sickle bar mower. Drive the boat onto center of trailer to avoid uneven distribution of weight and staying within local width restrictions. Tie down the boat as needed.

Retract swivel cylinder and place clear of boom. Pivot boom forward to the center of flat bed. Lower deck onto the trailer bed, and shut off the tractor. The tractor and the mower head should now be chained down securely to the trailer bed.

### **CAUTION!**



If any part of this operating section, or any other section of this manual is not completely understood, contact your Tiger dealer or the address on the cover of this manual for assistance

**OPERATION**

**INSPECTION SHEETS**



# OPERATION

## BOOM MOWER PRE-OPERATION Inspection



Mower ID# \_\_\_\_\_ Make \_\_\_\_\_

Date: \_\_\_\_\_ Shift \_\_\_\_\_

**WARNING!**



Before conducting the inspection, make sure the Tractor engine is off, all rotation has stop and the tractor is in the Park with the parking brake engaged. The Mower head is resting on the ground (or is securely blocked up and supported) and all hydraulic pressure has been relieved.

Item	Condition at Start of Shift	Specific Comments if not O.K.
The Operator's Manual is in the Canister on the mower		
All Safety Decals are in place and legible		
The Mounting frame bolts are in place and tight		
The Boom connection bolts & pins are tight		
There are no cracks in boom		
The Hydraulic Cylinders pins are tight		
The Hydraulic Pump hose connections are tight		
The Hydraulic Valve hose connections are tight		
The Hydraulic Valve controls function properly		
There are no leaking or damaged hoses		
The Hydraulic Oil level is full		
There is no evidence of Hydraulic leaks		
The Blades are not chipped, cracked or bent		
The Blade bolts are tight		
The Mower shields are in place and in good condition		
The Hydraulic motor mounting bolts are tight		
The pivot assembly and boom are properly lubricated		

Operators Signature: \_\_\_\_\_

**DO NOT OPERATE an UNSAFE TRACTOR or MOWER**

**OPERATION**

# **MAINTENANCE SECTION**

# MAINTENANCE

Tiger Mowers are designed for high performance and rugged durability, yet with simplified maintenance. The purpose of this section of the manual is to help the operator in the regular servicing of the mower. Regular maintenance at the intervals mentioned will result in the maximum efficiency and long life of the Tiger Mower.

When you purchase a Tiger Mower you also acquire another valuable asset, Tiger's parts organization. Our rapid and efficient service has guaranteed the customer satisfaction for many years. Tiger parts keep up with the demands for efficiency, safety and endurance expected of the Tiger Mower.

## MAINTENANCE PRECAUTIONS

- Be sure end of grease gun and zerks are clean before using. Debris injected into bearings, etc. with grease will cause immediate damage.
- DO NOT use a power grease gun to lubricate bearings. These require very small and exact amounts of lubrication. Refer to the detailed maintenance section for specific lubrication instructions. DO NOT over-grease bearings.
- Be alert to maintenance indicators such as the in-tank filter pressure gauge, hydraulic reservoir sight gauge, etc. Take the required action to correct any problems immediately.
- Release of energy from pressurized systems may cause inadvertent actuation of cylinders, or sudden release of compressed springs. Before disconnecting any hoses relieve pressure by shutting tractor off, setting cutter on ground and actuating lift valve handles.

**DO NOT** use hands to check for suspected leaks in hydraulic hoses! Hydraulic fluid escaping under pressure can have sufficient force to penetrate skin and cause serious injury. If fluid is injected into skin, it must be surgically removed within a few hours or gangrene may result. Use a small piece of wood or cardboard, not hands, to search for pin hose leaks. Be sure all pressure is relieved whenever disconnecting lines. Be sure all connections are tight and hoses and lines are not damaged before applying pressure.

WARNING!



## BREAK IN PERIOD

In addition to following the break in instructions for your particular boat, the in-line hydraulic fluid filter should be replaced after the first 50 hours of service. Thereafter the filter should be replaced every 500 hours, or yearly, which ever comes first.

# MAINTENANCE

**DANGER!**



Never work under the Implement, the framework, or any lifted component unless the Implement is securely supported or blocked up to prevent sudden or inadvertent falling which could cause serious injury or even death. (SG-14)



**WARNING!**



Do not modify or alter this Implement. Do not permit anyone to modify or alter this Implement, any of its components or any Implement function. (SG-8)

**WARNING!**



Relieve hydraulic pressure prior to doing any maintenance or repair work on the Implement. Place the Mower Head on the ground or securely supported on blocks or stands and turn off the engine. Push and pull the control Levers several times to relieve pressure prior to starting any maintenance or repair work. (SBM-6)

**DANGER!**



Always disconnect the wire leads from the mower pump solenoid before performing service on the Boat or Mower. Use caution when working on the Boat or Mower. Boat engine must be stopped before working on Mower or Boat. The Mower Blades could inadvertently be turned on without warning and cause immediate dismemberment, injury or death. (SBM-12a)

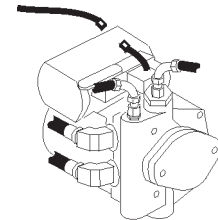

# MAINTENANCE

## REGULAR MAINTENANCE

The intervals at which regular servicing should be done are based on hours of operation. Use the tractors hour meter to determine when regular servicing is required.

### DAILY OR EVERY 8 HOURS

<b>ITEM</b>	<b>SERVICE</b>	<b>COMMENTS</b>
Pivot Points	Lubricate	Inject grease until it appears at ends
Hydraulic Fittings	Check for leaks	Tighten when needed. Do Not use hands to check for leaks, see maint. Precautions
Knives	Check	Inspect for missing or damaged knives, change as needed
Knife mounting bolts	Check	Re-torque bolts to torque specifications in this section
Main Frame and Deck	Check	Retorque bolts to torque specifications in this section
Hydraulic Fluid Level	Check	Add if required per fluid recommendations

# MAINTENANCE

## WEEKLY OR EVERY 50 HOURS

ITEM	SERVICE	COMMENTS
In-line Hyd. Fluid Filter <b>(10 micron filter)</b>	Change	Change after first 50 hours only, then every 500 hours or yearly
In-Tank Hyd. Screen	Clean	Clean after first 50 hours only, then every 500 hours or yearly

## MONTHLY OR EVERY 150 HOURS

Hydraulic Fluid Level	Check	Add as needed
Hyd. Tank Breather	Clean / Check / Replace	Clean or replace Element as required

## YEARLY OR EVERY 500 HOURS

Hyd. Tank Fluid	Change
In-line Hyd. Fluid Filter <b>(10 micron filter)</b>	Change
In-Tank Hyd. Screen	Clean
Hyd. Tank Breather	Change

## TROUBLESHOOTING

SYMPTOMS	CAUSE	REMEDY
<b>Vibration</b>	1. Loose bolts	1. Check all bolts and tighten to recommended torque specs.
	2. Mower assembly unbalanced	2a. Check for damaged blades. Replace if needed. 2b. Check for wire, rope, etc. entangled in mower assembly
<b>Mower will not lift</b>	1. Hyd. Fluid low	1. Check and refill Hyd. Fluid Check In-Tank Hyd. Screen
	2. Leaks in line	2. Tighten or replace fittings and hoses
	3. Faulty relief valve	3. Check pressure in line. Line pressure in Control Valve should be at least 2500 P.S.I.
	4. Kinked or blocked	4. Clean or replace lines
	5. Faulty cylinder	5. Inspect, repair or replace cylinder

# MAINTENANCE

SYMPTOMS	CAUSE	REMEDY
<b>Mower will not start or run</b>	<ol style="list-style-type: none"> <li>1. Low oil level</li> <li>2. Line leak</li> </ol>	<ol style="list-style-type: none"> <li>1. Check Hyd. tank and fill</li> <li>2. Check all fittings and lines, re-tighten or replace</li> </ol>
<b>Motor turns slowly or not at all.</b>	<ol style="list-style-type: none"> <li>1. Contaminants restricting spool movement in valve body.</li> <li>2. Suction lines obstructed</li> <li>3. Low oil level</li> </ol>	<ol style="list-style-type: none"> <li>1. Remove large nut on side of large valve block. Remove spring, and use needle nose vise grip to pull spool from block. Check block and spool for contaminants and scratches. Clean parts or replace if scratched.</li> <li>2. Check for kinks or obstruction in suction hose.</li> <li>3. Check Hyd. tank level and fill.</li> </ol>
<b>Pump will not work</b>	<ol style="list-style-type: none"> <li>1. Excessive wear on internal parts</li> </ol>	<ol style="list-style-type: none"> <li>1. Disassemble and repair.</li> </ol>
<b>Motor will not work</b>	<ol style="list-style-type: none"> <li>1. Excessive wear on internal parts</li> </ol>	<ol style="list-style-type: none"> <li>1. Disassemble and repair.</li> </ol>

NOTE: If flow meter is available, check pressure and flow volume for all suspected hydraulic problems.





**If the solution to your problem cannot be found in this section, call the Technical Service representative at the number shown on the front cover of this manual.**



# MAINTENANCE

## TORQUE SPECIFICATIONS

### Torque for Standard Fasteners

Nominal Dia. (in.)	threads per inch	 Grade 2			 Grade 5			 Grade 8			 Grade 9		
		Tightening Torque			Tightening Torque			Tightening Torque			Tightening Torque		
		Lubed K = 0.15	Dry Plated K = 0.17	Dry plain K = 0.20	Lubed K = 0.15	Dry Plated K = 0.17	Dry plain K = 0.20	Lubed K = 0.15	Dry Plated K = 0.17	Dry plain K = 0.20	Lubed K = 0.15	Dry Plated K = 0.17	Dry plain K = 0.20

#### Unified Coarse Thread Series



1/4	20	49 in-lbs	59 in-lbs	66 in-lbs	76 in-lbs	86 in-lbs	101 in-lbs	107 in-lbs	122 in-lbs	143 in-lbs	126 in-lbs	143 in-lbs	168 in-lbs
5/16	18	101	122	135	157	178	209	221	251	295	259	294	346
3/8	16	15 ft-lbs	18 ft-lbs	20 ft-lbs	23 ft-lbs	26 ft-lbs	31 ft-lbs	33 ft-lbs	37 ft-lbs	44 ft-lbs	38 ft-lbs	43 ft-lbs	51 ft-lbs
7/16	14	24	29	32	37	42	49	52	59	70	61	70	82
1/2	13	37	44	49	57	64	75	80	90	106	94	106	125
9/16	12	53	63	70	82	92	109	115	130	154	135	153	180
5/8	11	73	87	97	113	128	150	159	180	212	186	211	248
3/4	10	129	155	172	200	227	267	282	320	376	331	375	441
7/8	9	125	150	167	322	365	429	455	515	606	533	604	710
1	8	187	225	250	483	547	644	681	772	909	799	905	1065
1 1/8	7	266	319	354	596	675	794	966	1095	1288	1132	1283	1510
1 1/4	7	375	450	500	840	952	1121	1363	1545	1817	1597	1810	2130
1 1/2	6	652	783	869	1462	1657	1950	2371	2688	3162	2779	3150	3706

#### Fine Thread Series

1/4	28	96 in-lbs	68 in-lbs	75 in-lbs	87 in-lbs	99 in-lbs	116 in-lbs	123 in-lbs	139 in-lbs	164 in-lbs	144 in-lbs	163 in-lbs	192 in-lbs
5/16	24	112	135	150	174	197	231	245	278	327	287	325	383
3/8	24	17 ft-lbs	20 ft-lbs	23 ft-lbs	26 ft-lbs	30 ft-lbs	35 ft-lbs	37 ft-lbs	42 ft-lbs	49 ft-lbs	43 ft-lbs	49 ft-lbs	58 ft-lbs
7/16	20	27	32	36	41	47	55	58	66	78	68	78	91
1/2	20	41	49	55	64	72	85	90	102	120	105	120	141
9/16	18	59	71	78	91	103	121	128	146	171	151	171	201
5/8	18	82	99	110	127	144	170	180	204	240	211	239	281
3/4	16	144	173	192	223	253	297	315	357	420	369	418	492
7/8	14	138	165	184	355	403	474	502	568	669	588	666	784
1	14	210	252	280	542	614	722	765	867	1020	896	1016	1196
1 1/8	12	298	357	397	668	757	890	1083	1227	1444	1269	1439	1693
1 1/4	12	415	498	553	930	1055	1241	1509	1710	2012	1768	2004	2358
1 1/2	12	734	890	978	1645	1865	2194	2668	3024	3557	3127	3544	4169

Torque values for 1/4 and 5/16-in series are in inch-pounds. All other torque values are in foot-pounds. K = 0.15 for "lubricated" conditions. D = Nominal Diameter  
 Torque values calculated from formula T=KDF, where K = 0.17 for zinc plated and dry conditions F = Clamp Load  
 K = 0.20 for plain and dry conditions

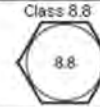
### Torque-Tension Relationship for Metric Fasteners

Nominal Dia. (mm)	Pitch	 Class 4.6			 Class 8.8			 Class 10.9			 Class 12.9		
		Tightening Torque			Tightening Torque			Tightening Torque			Tightening Torque		
		Lubed K = 0.15	Dry Plated K = 0.17	Dry plain K = 0.20	Lubed K = 0.15	Dry Plated K = 0.17	Dry plain K = 0.20	Lubed K = 0.15	Dry Plated K = 0.17	Dry plain K = 0.20	Lubed K = 0.15	Dry Plated K = 0.17	Dry plain K = 0.20
3	0.5	0.28	0.32	0.38	0.73	0.82	0.97	1.0	1.2	1.4	1.2	1.6	
3.5	0.6	0.44	0.50	0.59	1.1	1.3	1.5	1.6	1.9	2.2	1.9	2.5	
4	0.7	0.66	0.74	0.87	1.7	1.9	2.3	2.4	2.7	3.2	2.8	3.8	
5	0.8	1.3	1.5	1.8	3.4	3.9	4.5	4.9	5.5	6.5	5.7	7.6	
6	1	2.3	2.6	3.0	5.8	6.6	7.7	8.3	9.4	11	9.7	13	
6	1.25	2.1	2.3	2.7	5.3	6.0	7.0	7.6	8.6	10	8.8	12	
7	1	3.8	4.3	5.0	9.7	11	13	14	16	19	16	22	
8	1	5.9	6.6	7.8	15	17	20	22	24	29	25	34	
8	1.25	5.5	6.2	7.3	14	16	19	20	23	27	24	31	
10	1.25	11	13	15	29	33	39	42	48	56	49	66	
10	1.5	11	12	14	28	32	37	40	45	53	47	62	
12	1.25	21	23	28	53	60	71	76	86	101	89	119	
12	1.5	20	22	26	51	58	68	73	82	97	85	113	
12	1.75	19	21	25	49	55	65	70	79	93	81	108	
14	1.25	26	29	34	66	75	89	95	108	127	111	148	
14	1.5	28	32	37	72	82	96	103	117	138	121	161	
14	2	30	34	40	78	88	104	111	126	148	130	173	
16	1.5	50	57	67	129	146	171	184	208	245	215	287	
16	2	47	53	62	121	137	161	173	196	230	202	269	
18	1.5	73	82	97	187	212	249	268	303	357	313	417	
18	2.5	65	73	86	167	189	222	239	270	318	279	372	
20	2.5	91	104	122	236	267	314	337	382	449	394	525	

Clamp load calculated as 75% of the proof load for specified bolts. K = 0.15 for "lubricated" conditions. D = Nominal Diameter  
 All torque values are listed in foot-pounds. K = 0.17 for zinc plated, dry conditions F = Clamp Load  
 Torque values calculated from formula T=KDF, where K = 0.20 for plain and dry conditions

\* These are intended to be general specifications. See tractor operators or service manual for exact specifications for your unit.

# MAINTENANCE

## LUBRICATION RECOMMENDATIONS

Description	Application	General Specification	Recomended Mobil Lubricant
Mower Hydraulics	Reservoir	ECO friendly	Mobil EAL224H
Boom	Grease Gun	Lithium-Complex	Mobilgrease CM-S
Pivot Assembly	Grease Gun	Lithium-Complex	Mobilgrease CM-S
Cylinders	Grease Gun	Lithium-Complex	Mobilgrease CM-S

## MAINTENANCE

### RECOMMENDED FILLING INSTRUCTIONS FOR HYDRAULIC RESERVIOR

When filling or checking the oil level, the unit should be sitting on a level surface, shut **"OFF"**, and allowed sufficient time to cool to ambient temperature. Use caution when removing the pressurized breather. Do not place face over opening when removing the breather.

The reservoir should be filled to the middle of the sight glass on the side of the tank. Do not over-fill. The reservoir has been over-filled when oil level is above the sight glass. If tank has too much oil, the excess may be expelled through the pressurized breather.

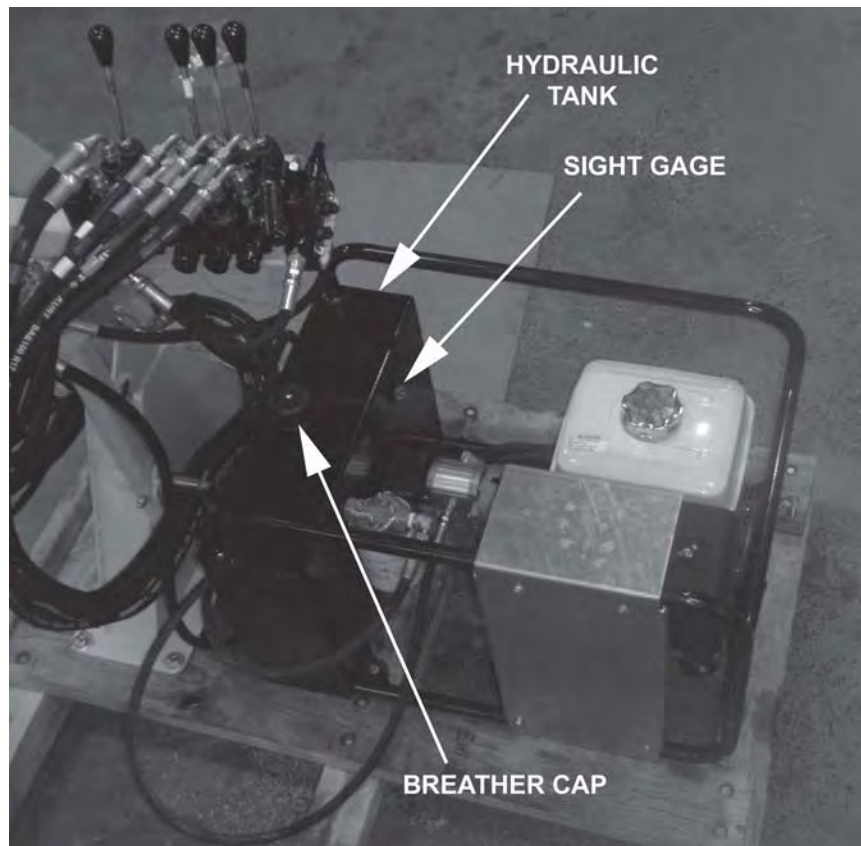

# MAINTENANCE

## GREASING POINTS ON BOOM AND PIVOT

Locate grease zerks on deck pivot assembly, at main / secondary boom joint, and at main boom / main frame joint. Inject Lithium-Complex Extreme Pressure grease conforming to NLG12-ISO 320 specifications until grease begins to protrude from ends.

PIVOT ASSY

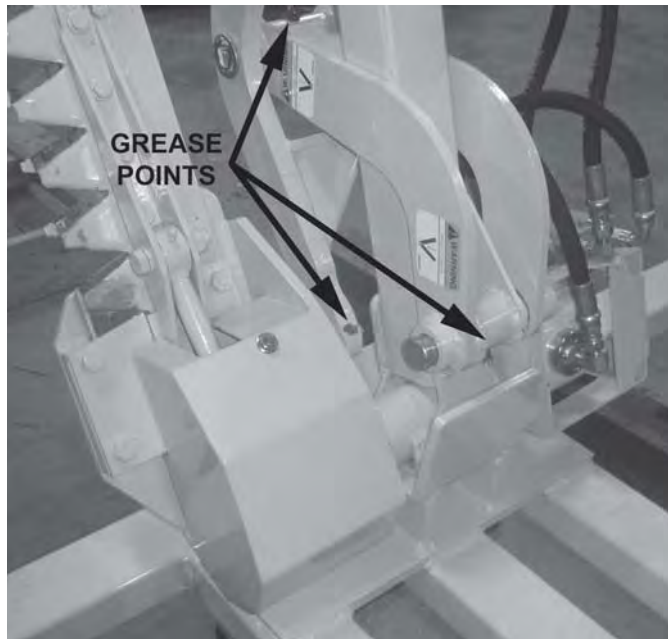

BOOM

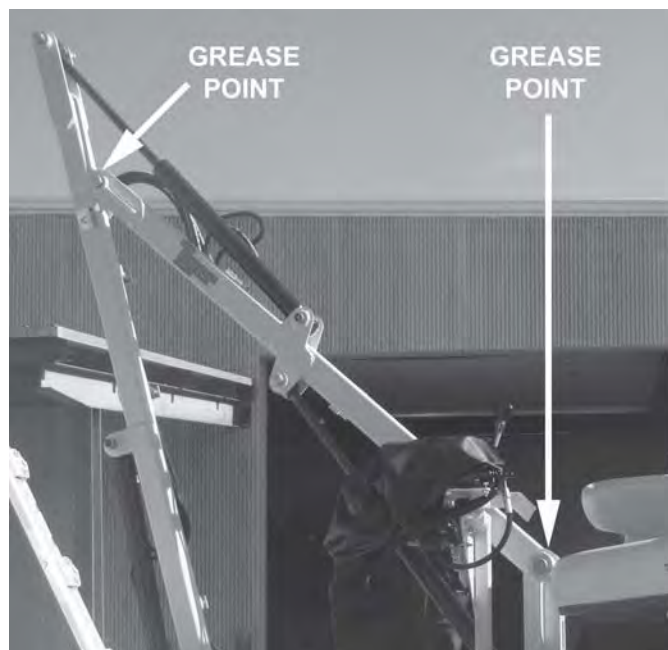

## MAINTENANCE

### GREASING BOOM CYLINDER(S) PIVOT POINTS

Locate the zerk on the butt end tang of cylinder and on rod end tang. Inject Lithium-Complex Extreme Pressure grease conforming to NLGI2-ISO 320 specifications until grease begins to protrude from ends. This procedure is to be used on the main boom cylinder, secondary boom cylinder, mower pivot cylinders daily or at 8 hour intervals.

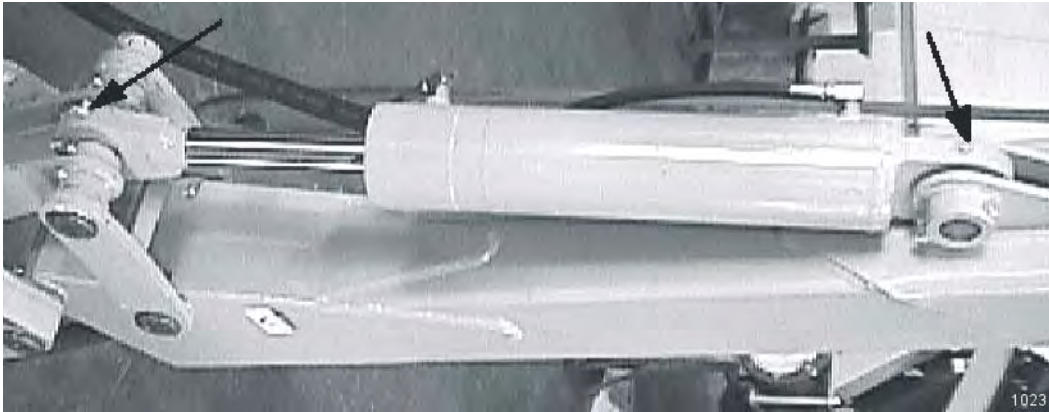

# MAINTENANCE

## DAILY MAINTENANCE SCHEDULE

The following services should be performed **daily** or every **8 hours** of service, following the detailed maintenance instructions in the operators manual.

\_\_\_\_\_ Pivot points: Inject grease until it appears at ends.

\_\_\_\_\_ Hydraulic fittings: Check for leaks with paper or cardboard. Tighten fittings or replace hoses immediately.

\_\_\_\_\_ Knives: Inspect for missing or damaged knives, change (only complete sets) as needed.

\_\_\_\_\_ Main Frame / Deck: Unless otherwise specified retorque bolts according to torque specifications in this section.

\_\_\_\_\_ Hydraulic Fluid Level: Add, if required, per fluid recommendations.

Service performed by: \_\_\_\_\_ Date: \_\_\_\_/\_\_\_\_/\_\_\_\_ Hour  
Meter: \_\_\_\_\_

### Maintenance Section

\*\* This page may be copied and used as part of the daily maintenance routine.

# SICKLE BAR MOWER

## PARTS SECTION

# PARTS ORDERING GUIDE

The following instructions are offered to help eliminate needless delay and error in processing purchase orders for the equipment in this manual.

1. The Parts Section is prepared in logical sequence and grouping of parts that belong to the basic machine featured in this manual. Part Numbers and Descriptions are given to help locate the parts and quantities required.

2. The Purchase Order must indicate the **Name and Address** of the person or organization ordering the parts, **who should be charged**, and if possible, the **serial number of the machine** for which the parts are being ordered.

3. The purchase order must clearly list the **quantity of each part**, the complete and correct **part number**, and the basic **name of the part**.

4. The manufacturer reserves the right to substitute parts where applicable.

5. Some parts may be unlisted items which are special production items not normally stocked and are subject to special handling. Request a quotation for such parts before sending a purchase order.

6. The manufacturer reserves the right to change prices without prior notice.

NOTE: When ordering replacement decals, refer to the part numbers and descriptions listed in the safety section in the front of this manual.



1000

For maximum safety and to guarantee optimum product reliability, always use genuine **Tiger** replacement parts. The use of inferior replacement parts may cause premature or catastrophic failure which could result in serious injury or death.

Direct any questions regarding parts to:

**Tiger Corporation**  
3301 N. Louise Ave.  
Sioux Falls, SD 57107  
**1-800-843-6849**  
**1-605-336-7900**



# PARTS SECTION TABLE OF CONTENTS

<b>SECTION</b>	<b>PAGE</b>
BOOM ASSEMBLY 1	5-4
BOOM ASSEMBLY 2	5-6
HYDRAULICS ASSEMBLY	5-8
SICKLE BAR DRIVE ASSEMBLY	5-10
SICKLE BAR KNIFE ASSEMBLY	5-12
VALVE BREAKDOWN	5-14

# SICKLE BAR MOWER - BOOM ASSEMBLY

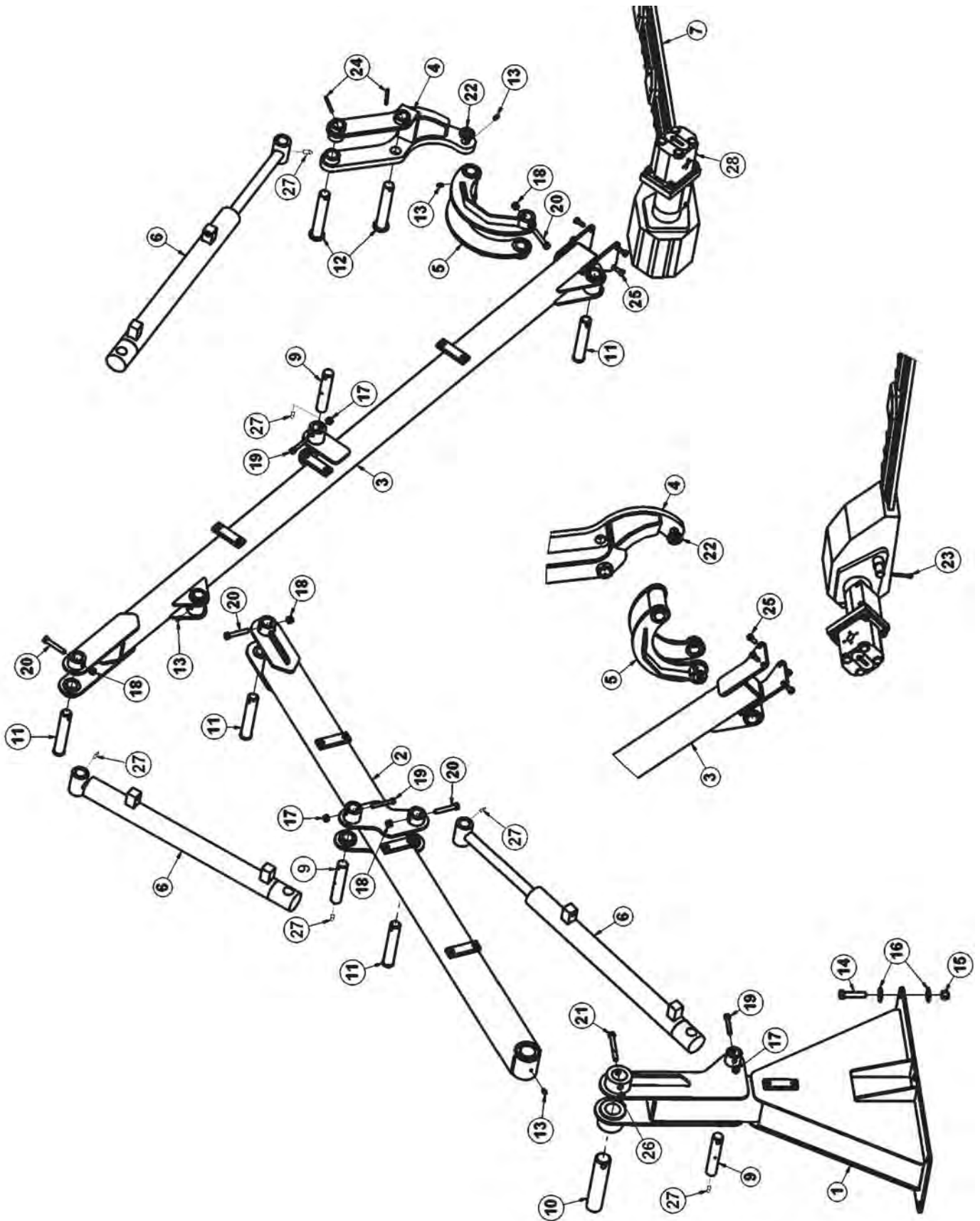

# SICKLE BAR MOWER - BOOM ASSEMBLY

ITEM	P/N	QTY	DESCRIPTION
1	06310120	1	MNT,BOOM
2	06310121	1	BOOM,MAIN
3	06310122	1	BOOM,SEC
4	06310123	1	LINKAGE,1
5	06310124	1	LINKAGE,2
6	06770046	3	CYLINDER ASSEMBLY,TAPPED
7	06520431	1	SICKLE BAR,ESM
8	06520420	1	KIT,ENGINE
9	52107-4	3	PIN YDP, 1.00 X 5.25"
10	40332	1	PIN SHAFT
11	33503	4	PIN,1X5.75",W/HOLE
12	06360002	2	PIN,1.00x5.87,W.25HOLE,CAP
13	6T3207	5	GREASE ZERK,1/4"
14	21734	6	CAPSCREW, 1/2 x 2-1/4,NC
15	21727	6	NYLOCK NUT, 1/2
16	22018	12	FLATWASHER,1/2",WIDE
17	21577	3	HEX NUT,NYLOCK,5/16" NC
18	21627	5	NYLOCK NUT,3/8",NC
19	21585	3	CAPSCREW, 5/16 x 2 1/4,NC
20	21635	5	CAPSCREW,3/8x2 1/4,NC
21	21688	1	CAPSCREW,7/16" X 3-1/4" NC
22	33880	1	FLATWASHER,3/4",GR 8,SAE
23	22533	1	COTTER PIN,3/16 X 2
24	06537021	2	ROLL PIN, 5MM x 50MM
25	27508	4	CAPSCREW,8MMx20MM(1.25 PITCH)
26	21677	1	HEX NUT,NYLOCK,7/16" NC
27	6T3211	6	GREASE ZERK, 1/8"
28	06520432	1	MOTOR

# SICKLE BAR MOWER - BOOM ASSEMBLY 2

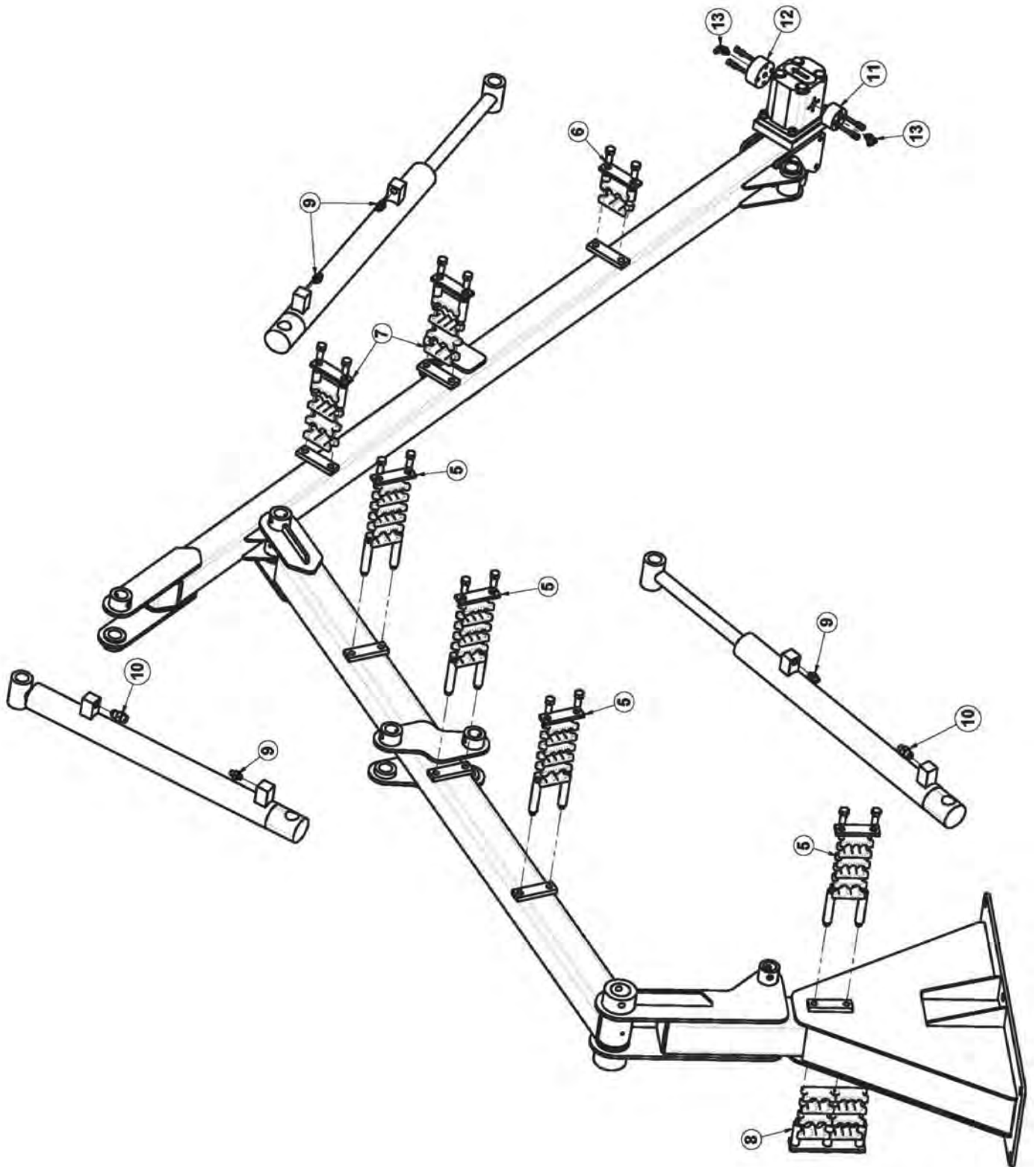

## SICKLE BAR MOWER - BOOM ASSEMBLY 2

ITEM	P/N	QTY	DESCRIPTION
1	06310120	1	MNT,BOOM
2	06310121	1	BOOM,MAIN
3	06310122	1	BOOM,SEC
4	06770046	3	CYLINDER ASSEMBLY,TAPPED
5	06505117	4	CLAMP KIT,HOSE,.63x2,.5x6,2PST
6	06505119	1	CLAMP KIT,HOSE,.63x2,2PST
7	06505120	2	CLAMP KIT,HOSE,.63x2,.5x3,2PST
8	06505121	1	CLAMP KIT,HOSE,.63x4,.5x6,3PST
9	32901	4	ADAPTER,3/8MORx3/8MJ
10	06503146	2	ADAPTER,3/8MORx3/8MJ,CHCK RES
11	06503137	1	KIT,FLANGE,30mm
12	06503138	1	KIT,FLANGE,40mm
13	06503144	2	ELBOW,3/8BSPPx3/8MJ

# SICKLE BAR MOWER - HYDRAULICS ASSEMBLY

- A - SEC 1, A PORT OF VLV TO MAIN BOOM CYL BUTT
- B - SEC 1, B PORT OF VLV TO MAIN BOOM CYL GLAND
- C - SEC 2, A PORT OF VLV TO SEC BOOM CYL BUTT
- D - SEC 2, B PORT OF VLV TO SEC BOOM CYL GLAND
- E - SEC 3, A PORT OF VLV TO MOWER ROTATING CYL GLAND
- F - SEC 3, B PORT OF VLV TO MOWER ROTATING CYL BUTT
- G - SEC 4, A PORT OF VLV TO MOWER MOTOR RETURN
- H - SEC 4, B PORT OF VLV TO MOWER MOTOR PRESSURE
- J - #1 PORT OF FLOW CNTRL VLV TO PUMP PRESSURE
- K - #2 PORT OF FLOW CNTRL VLV TO MID INLET OF VLV
- L - #3 PORT OF FLOW CNTRL VLV TO MAIN INLET OF VLV
- M - RETURN TO HYDRAULIC FILTER ON TANK
- N - DRAIN PORT TO TEE ON TANK PORT
- P - SUCTION PORT OF TANK TO PUMP

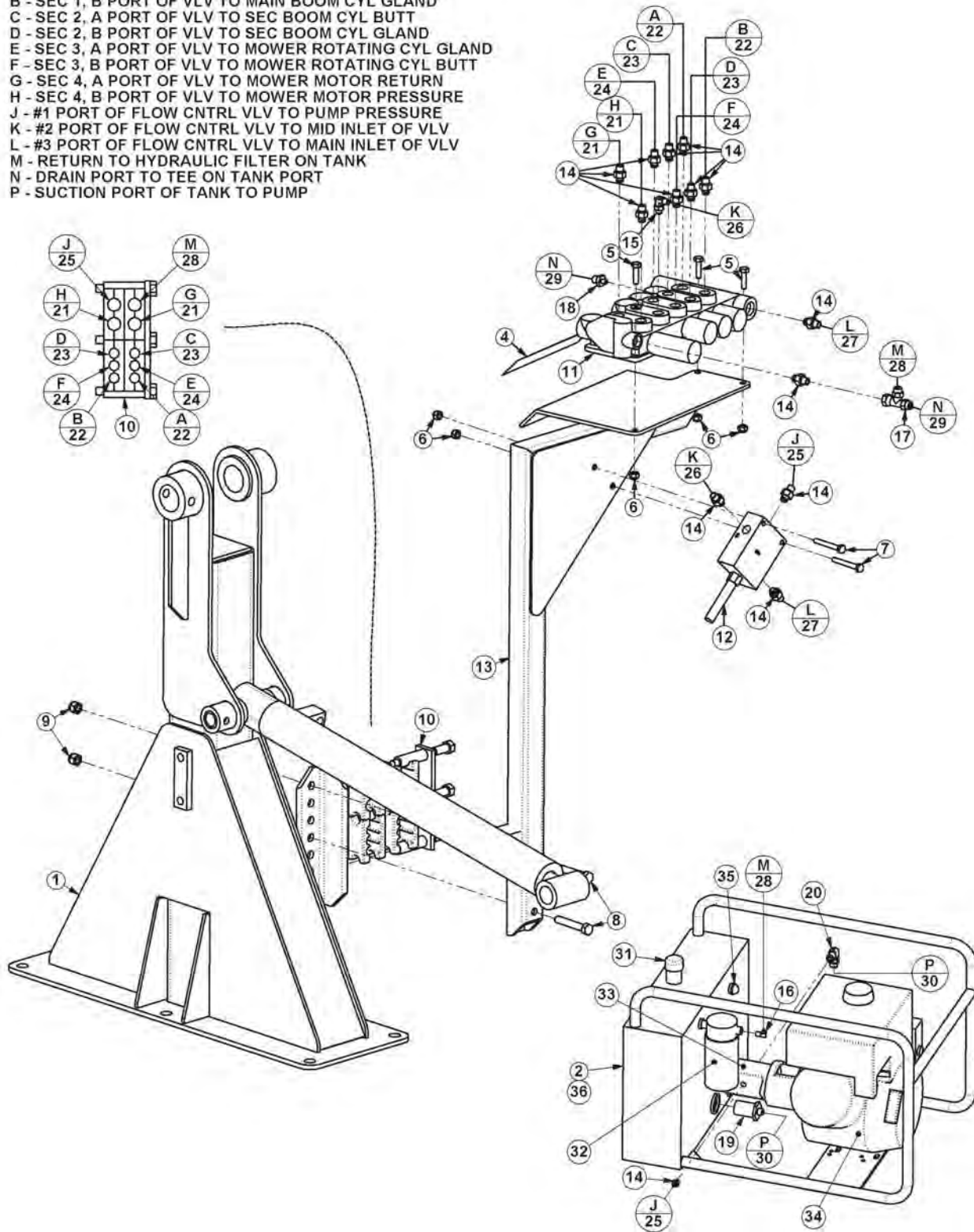

# SICKLE BAR MOWER - HYDRAULICS ASSEMBLY

ITEM	P/N	QTY.	DESCRIPTION
1	06310120	1	MNT,BOOM,WEEDOO
2	REF	1	KIT,ENGINE,WEEDOO
3	6T3207	3	GREASE ZERK,1/4"
4	06550056	1	DECAL,CNTRL,WEEDOO
5	21530	3	CAPSCREW,1/4" X 1" NC
6	21527	5	HEX NUT,NYLOCK,1/4" NC
7	21534	2	CAPSCREW,1/4 x 2 NC
8	21635	2	CAPSCREW,3/8x2 1/4,NC
9	21627	2	NYLOCK NUT,3/8",NC
10	06505121	1	CLAMP KIT,HOSE, .63x4, .5x6,2PST
11	06502118	1	VLV,4SP,BRAND,WEEDOO
12	06502122	1	FLW CNTRL,WEEDOO
13	06340034	1	VLV MNT,WEEDOO
14	32901	15	ADAPTER,3/8 MOR X 3/8 MJ
15	32902	1	ELBOW,3/8MORx3/8MJ
16	33399	1	ELBOW,1/2MPX3/8MJ 90
17	06503048	1	RUN TEE,3/8MJ x 3/8FJX x 3/8MJ
18	06503145	1	ADAPTER,3/16MORx1/4MJ
19	06520452	1	SUCTION STRAINER
20	33382	1	ELBOW,1/2 MJx1/2 ORB
21	06500505	2	HOSE,#6x230(6FJXx6FJX90)
22	33561	2	HOSE,#4x105(6FJX90x6FJX)
23	06500061	2	HOSE,#4x166(6FJXx6FJX90)
24	06500164	2	HOSE,#4x216(6FJX90x6FJX)
25	06500506	1	HOSE,#6x101(6FJX90x6FJX)
26	33411	1	HOSE,#4x24(6FJX90x6FJX)
27	06500434	1	HOSE,#4x18(6FJXx6FJX90)
28	06500507	1	HOSE,#6x97(6FJXx6FJX)
29	06500508	1	HOSE,#4x22(4FJX90x6FJX)
30	06500531	1	HOSE,#8x18(8FJXx12MP)
31	06520451	1	CAP,BREATHER
32	06520450	1	ELEMENT,FILTER
33	06520442	1	PUMP
34	06520440	1	ENGINE
35	06520445	1	SIGHT GLASS
36	06505128	1	TANK,WEEDOO

# SICKLE BAR MOWER - DRIVE ASSEMBLY

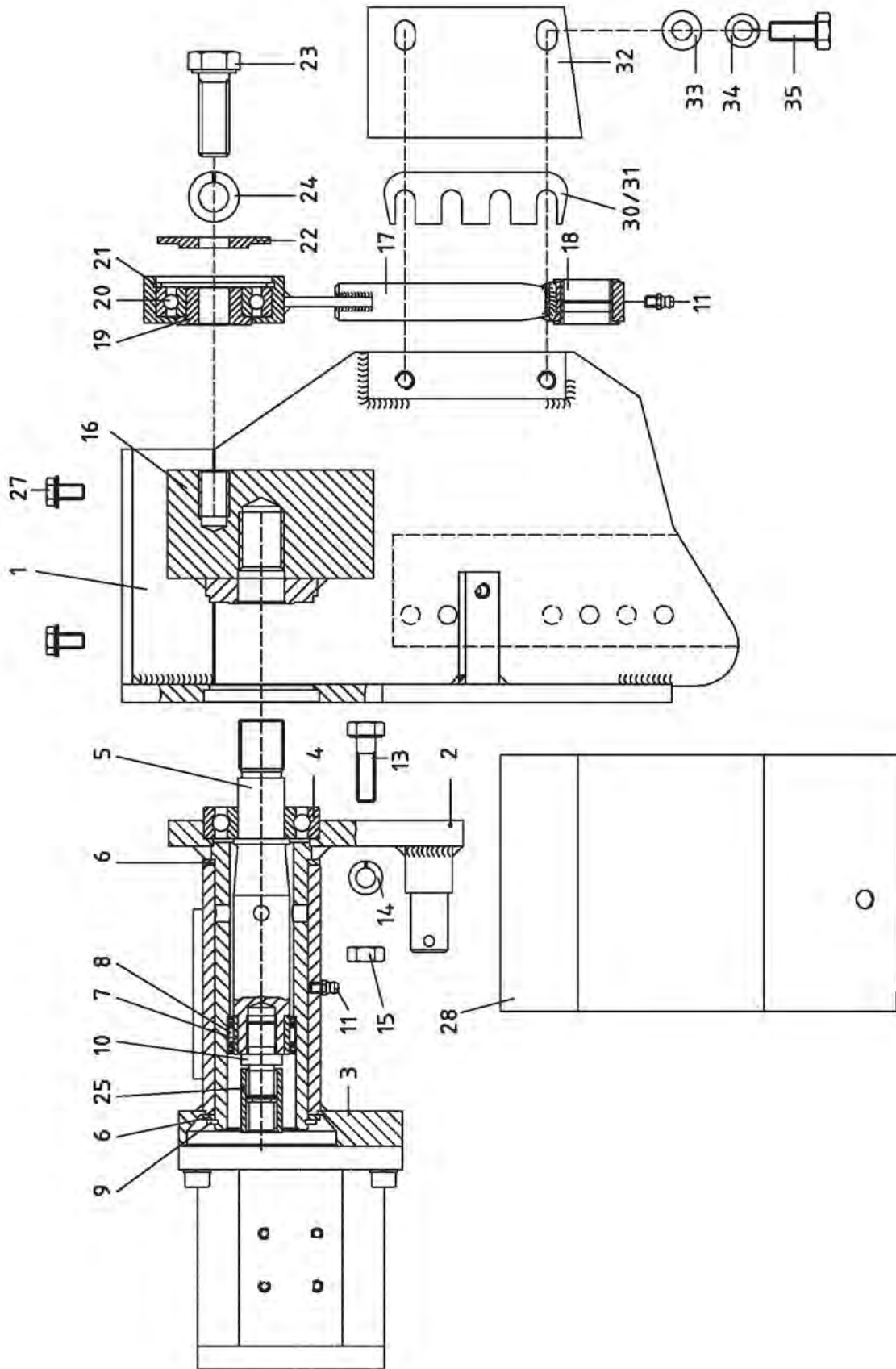

Parts Section 5-10



# SICKLE BAR MOWER - DRIVE ASSEMBLY

ITEM	PN	DESCRIPTION
1	273 0060	CARRIER
	<u>280 0740</u>	<u>SUPPORT</u>
2	280 0730	ARTICULATION
3	285 0150	FLANGE
4	590 0520	GROOVED BALL BEARING,6305 2RS
5	300 5050	SHAFT
6	555 1250	SHIM RING,SS,50x62x3
7	590 2190	INNER RING,LR,25x30x20,5
8	590 1440	NEEDLE BUSHING,H3020 2RS
9	566 0140	RETAINING RING,50x2,0
10	323 1150	COUPLER
11	557 0010	GREASE NIPPLE
13	560 2650	HEXAGON BOLT M10x35
14	565 0120	LOCKWASHER A10
15	537 0410	HEXAGON NUT
16	281 1640	CRANK DISK
	<u>280 1160</u>	<u>CONNECTING ROD CPLT</u>
17	280 1140	CONNECTING ROD
18	502 0120	BUSHING GFM
19	324 0590	BUSHING
20	590 0450	GROOVED BALL BEARING
21	566 0210	RETAINING RING
22	367 0500	WASHER
23	560 3130	HEXAGON BOLT M16x45
24	565 0170	LOCKWASHER A16
25	324 1650	CLUTCH BUSHING
27	562 0410	SCREW WITH RIPP FLANGE M8x12
28	276 0120	SAFETY COVER
30	363 1030	SHIM 0.2MM
31	363 1040	SHIM 0.5MM
32	332 1210	GUIDE PLATE FRONT
33	555 0200	WASHER,10.5
34	565 0120	SPRING WASHER,A10
35	560 2630	HEXAGON BOLT,10x25

# SICKLE BAR MOWER - KNIFE ASSEMBLY

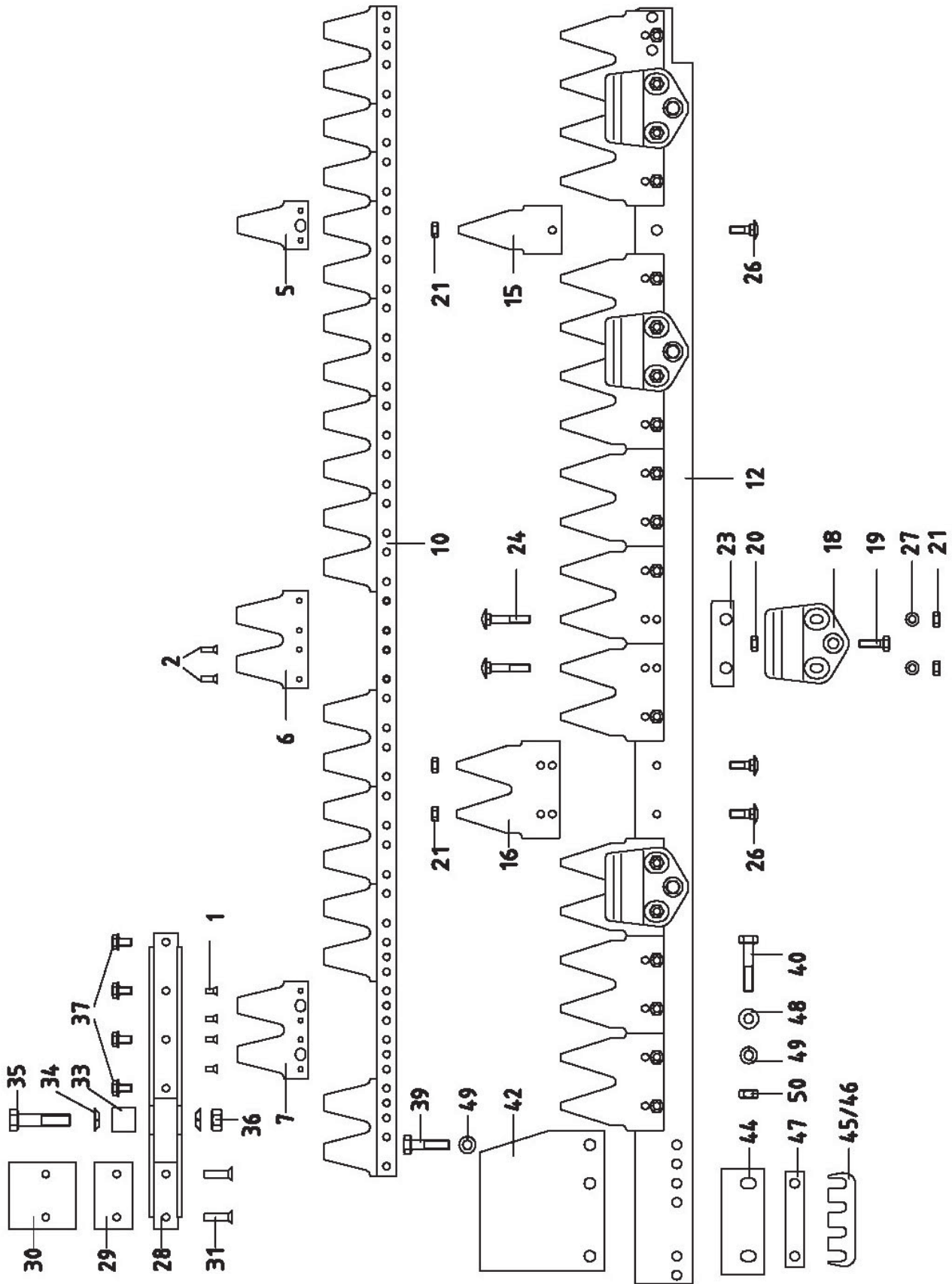

# SICKLE BAR MOWER - KNIFE ASSEMBLY

ITEM	PN	DESCRIPTION
	260 1700	MOWER KNIFE
1	544 0111	CTSK RIVET 5x12
2	544 0151	CTSK RIVET 5x17
5	344 1331	KNIFE SECTION
6	344 1311	DOUBLE KNIFE SECTION
7	344 1321	DOUBLE KNIFE SECTION
10	355 1350	KNIFE BACK
12	304 0730	BAR BACK
15	321 0021	BAR SECTION
16	321 1061	DOUBLE BAR SECTION
18	267 0860	KNIFE HOLDER
19	560 2230	HEXAGON BOLT
20	537 0610	LOCKNUT
21	537 0420	HEXAGON NUT M8
23	332 0280	GUIDE PIECE
24	559 0130	ROUND HEAD SCREW M8x45
26	559 0030	ROUND HEAD SCREW M8x23
27	555 0810	CONICAL SPRING WASHER,8
	247 2590	<u>KNIFE HEAD</u>
28	247 2580	KNIFE HEAD
29	332 1240	GUIDE PLATE
30	332 1230	GUIDE PLATE
31	544 0601	CTSK RIVET 8 x 25
33	324 0780	SPACER BUSH
34	565 0200	SPRING WASHER C12,5
35	560 0910	HEXAGON BOLT,M12x55
36	537 0810	LOCKNUT,NM12
37	562 0410	SCREW WITH RIPP FLANGE M8x12
	137 0100	<u>DRIVE ASSEMBLY - PREVIOUS PAGE</u>
39	560 0610	HEXAGON BOLT,M10x40
40	560 0600	HEXAGON BOLT,M10x50
42	321 2010	CUTTING PLATE
44	332 1220	GUIDE PLATE REAR
45	363 1030	SHIM 0.2MM
46	363 1040	SHIM 0.5MM
47	363 1320	SHIM 3.0MM
48	555 0200	WASHER 10.5
49	565 0120	SPRING WASHER A10
50	537 0410	HEXAGON NUT M10
	925 0120	PVC PROTECTION

# SICKLE BAR MOWER - VALVE BREAKDOWN

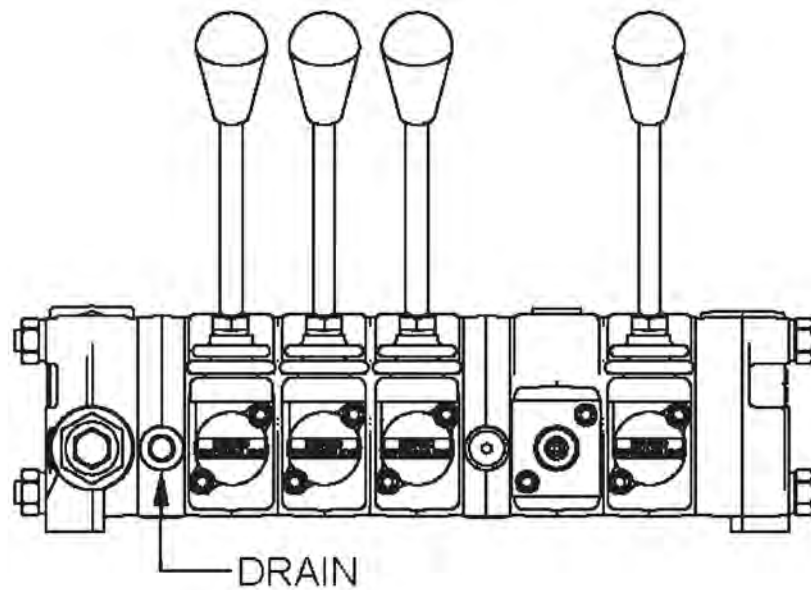
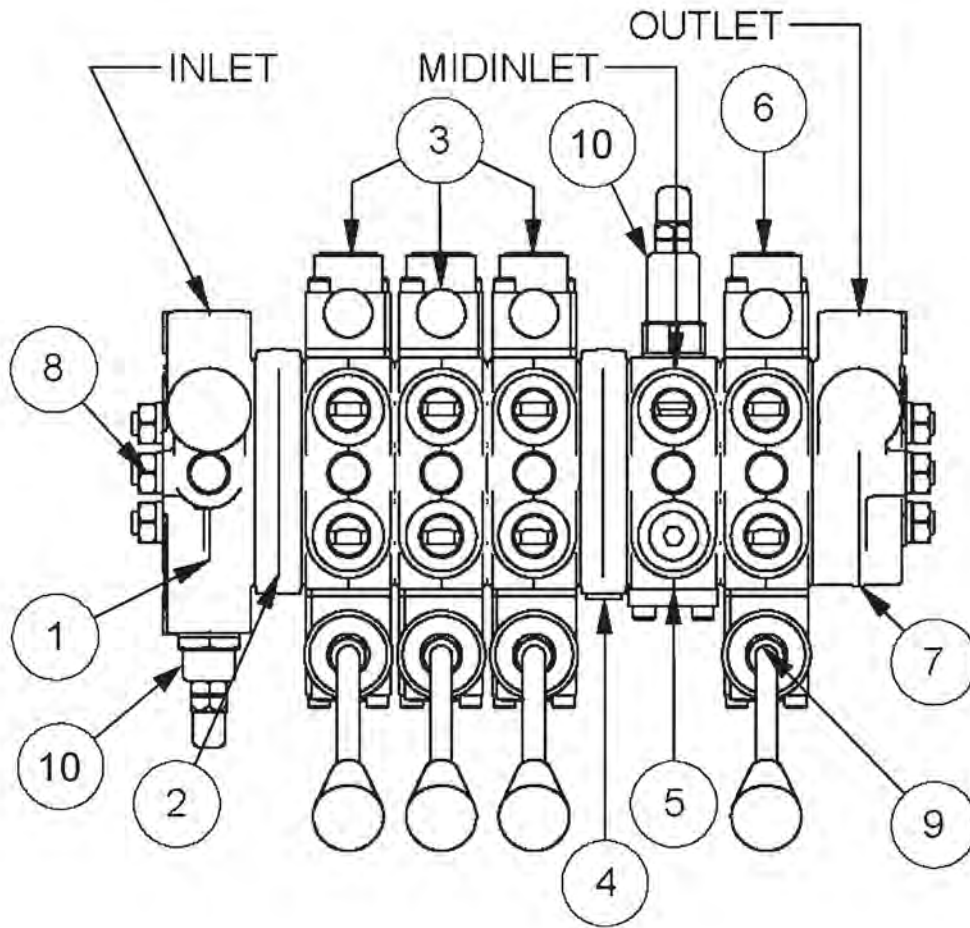

## SICKLE BAR MOWER - VALVE BREAKDOWN

ITEM	P/N	QTY.	DESCRIPTION
-	06502118	REF	VALVE,SICKLE BAR MOWER
1	20PG1B25	1	INLET
2	REF	1	DRAIN BLOCK
3	20BFST4SB	3	WORK SECTION,SPRING CENTERED
4	REF	1	SERIES BLOCK
5	20BFMICB25	1	MIDINLET
6	20BFO42DB	1	WORK SECTION,DETENT
7	20TG1	1	OUTLET
8	20TR6	1	TIE-ROD KIT
9	20HB	4	HANDLE
10	SUB-20B2	2	RELIEF
11	20BK	-	SEAL KIT - BETWEEN SECTIONS
12	20CK	-	SEAL KIT - INLET SECTION
13	20AK-S	-	SEAL KIT - WORK SECTION,SPRING CENTERED
14	20AK	-	SEAL KIT - WORK SECTION,DETENT

# NOTES

**WARRANTY  
SECTION**





## WARRANTY INFORMATION

Tiger Corporation, 3301 N. Louise, Sioux Falls, South Dakota, warrants to the original Retail Customer, the new Tiger equipment is free of defects in material and workmanship. Any part of equipment that in Tiger's judgement, show evidence of such defects will be repaired or replaced without charge, provided that the failure of part(s) shall have occurred within twelve (12) months from the date of delivery of said equipment to the Retail Customer. Expendable components such as knives, oil, chain sprockets, skid shoes, knife mounting disks and the like are excluded but not limited to this warranty.

The Retail Customer must pay the transportation cost to and from the Tiger Dealer's service shop for warranty service. Warranty service will be performed by the Tiger Dealer from whom the equipment was purchased, during service shop regularly scheduled days and hours of operation.

All Tiger obligation under this warranty shall be terminated if the equipment is modified or altered in ways not approved in writing by Tiger, if repair parts other than genuine Tiger repair parts have been used, or if the equipment has been subject to misuse, neglect, accident, improper maintenance or improper operation.

Tiger Corporation reserves the right to make improvements in design or changes in specification at any time without incurring any obligation to owners of equipment previously sold.

No agent or person has authority to alter, add to or waive the above warranties which are agreed to be in the only warranties, representations or promises, expressed or implied, as to the quality or performance of the products covered and which do not include any implied warranty of merchantability or fitness. In no event will Tiger be liable for incidental or consequential damages or injuries, including, but not limited to, loss of profits, rental or substitute equipment or other commercial loss.

**THERE ARE NO WARRANTIES WHICH EXTEND  
BEYOND THOSE EXPRESSED HEREIN.**

It is the Purchasers obligation to sign the warranty registration form **AFTER** he / she has Read and Understands the Operation and Safety Instructions stated within this manual.

## **ONE LAST WORD**

This manual cannot possibly cover all of the potentially hazardous situations you will encounter. By being familiar with the safety rules, operating and maintenance instructions in this manual you can help prevent accidents. The objective of this manual is to help make you a better operator. Remember, **SAFETY IS YOU!**



1012

Your safety and the safety of those around you depends on **YOU**. Common sense should play a large role in the operation of this machine.

Since we at Tiger Corporation are constantly striving to improve our products, we reserve the right to change specifications or design at any time.

## TO THE OWNER / OPERATOR / DEALER



To keep your implement running efficiently and safely, read your manual thoroughly and follow these directions and the Safety Messages in this manual and on the machine. The table of contents clearly identifies each section where you can easily find the information you need.

The Occupational Safety and Health Act (OSHA 1928.51 subpart C) makes the following minimum requirements for tractor operators.

### **OWNER REQUIREMENTS:**

1. Provide a Roll-Over-Protective Structure that meets the requirements of this Standard; and
2. Provide Seatbelts that meet the requirements of this Standard and SAE J3C; and
3. Ensure that each employee uses such Seatbelt while the tractor is moving; and
4. Ensure that each employee tightens the Seatbelt sufficiently to confine the employee to the protected area provided by the ROPS.

### **OPERATOR REQUIREMENTS:**

1. Securely fasten seatbelt if the tractor has a ROPS.
2. Where possible, avoid operating the tractor near steep ditches, embankments, and holes.
3. Reduce speed when turning, crossing slopes, and on rough, slick, or muddy surfaces.
4. Stay off slopes too steep for safe operation.
5. Watch where you are going – especially at row ends, on roads, and around trees.
6. Do Not permit others to ride.
7. Operate the tractor smoothly – no jerky turns, starts, or stops.
8. Hitch only to the draw-bar and hitch points recommended by the tractor manufacturer.
9. When the tractor is stopped, set brakes securely and use park lock, if available



Printed in USA  
© Tiger Corporation